

Wiring connection

1. This product is for 12V vehicle
2. Red - Accessory +12V
3. Blue - Reverse Trigger +12V
4. Black - Ground

Troubleshooting

1. Some or all of the sensors indicate Red on the display after the reverse trigger is engaged.
Check the wired connection to the sensors.
If the issue is not resolved, replace the sensor.
2. False detection when no object are nearby
Use the programming remote to check the system settings are set correctly according to the installation requirement.
Check that the sensors are installed in the correct orientation according to the table on page 6.
3. Check if sensors are connected according to the wiring diagram and all sensors have a good connection.

Installation Notes

1. After installation, check functions are normal before using the system.
2. Sensor need to be clear to perform properly. Remove any snow, ice, dirt, etc. from the sensors before using the system. Painting will also affect the detection ability.
3. Some object are not as easily detected such as sharp objects and smooth spherical objects.

Safety Information:

THE SYSTEM IS DESIGNED TO ASSIST YOU IN DETECTING OBSTACLES AND WILL NOT REPLACE SAFE DRIVING PRACTICE.

Voyager[®]
EXPAND your vision™

CVPS19

Sensor System with Graphic Overlay

Installation & Operation Manual

Part list

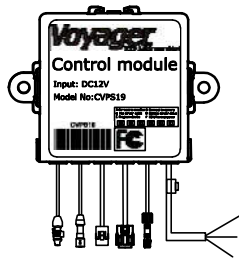

Control box * 1

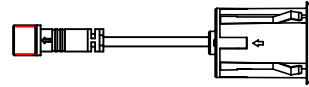

Sensor * 4

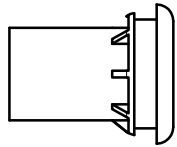

Rubber Isolator * 4

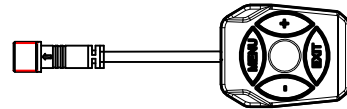

Wired Remote * 1

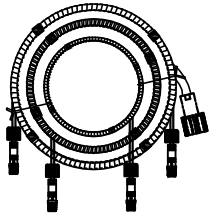

Bottom Sensor
Cable/Sensor Cable A * 1

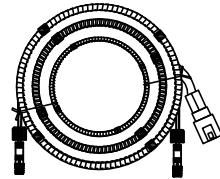

Top Sensor Cable/Sensor
Cable B * 1
(Sold Separately)

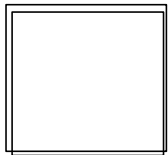

Manual * 1

4.3 Sensor Spacing

It is recommended to install the sensor with equal distance between each sensor.

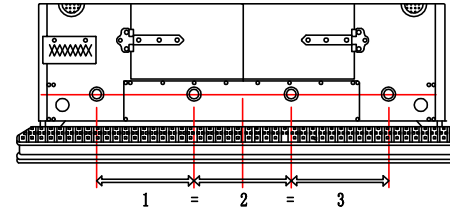

4.4 Sensor Distance setting

It is necessary to select the proper detection range according to vehicle size and preference. If Top Corner Display is set to OFF, the system will function as a 4 sensor system without top sensors.

4.5 Factory setting

Rear Step	<input type="radio"/> OFF <input type="radio"/> 0.5FT <input checked="" type="radio"/> 1FT <input type="radio"/> 1.5FT <input type="radio"/> 2FT
Sensitivity	<input type="radio"/> LOW <input type="radio"/> MIDDLE <input checked="" type="radio"/> HIGH
Installation Height	<input type="radio"/> 1-2FT <input checked="" type="radio"/> 2-3FT <input type="radio"/> 3-4FT
Top Corner Dis	<input type="radio"/> 5FT <input type="radio"/> 8FT <input type="radio"/> 10FT <input checked="" type="radio"/> OFF
Bottom Center Dis	<input type="radio"/> 5FT <input type="radio"/> 8FT <input checked="" type="radio"/> 10FT
Bottom Corner Dis	<input type="radio"/> 5FT <input type="radio"/> 8FT <input checked="" type="radio"/> 10FT
Language	<input checked="" type="radio"/> ENGLISH <input type="radio"/> SPANISH
Factory Settings	<input checked="" type="radio"/> NO <input type="radio"/> YES

4.6 Learn function

If a fixed object is mounted on the vehicle (rear mounted tire, handle, etc.) the system will recognize it as an obstacle. The Learn Function can be used to ignore these fixed obstacles.

4.6.1 Install the system and then place the vehicle in a open space without obstacles nearby.

4.6.2 Engage the reverse gear, press EXIT for 5 seconds, the system will record the fixed object. Alternative you can engage the reverse gear 4 times at 1-2 second intervals.

4.6.3 Note: If the Rear Step setting is changed, the Learn Function memory will be cleared.

4.7 Software version checking

While in System Setting menu, select Factory Settings and press "+" twice. The system will display the software version.

4.1 Rear Step setting

Select the proper STEP setting according to the vehicle installation. System will ignore any vehicle step within the selected STEP setting.



4.2 Sensitivity and installation height setting

For best performance of the system, the proper sensitivity, installation height, and sensor orientation must be chosen.

Please note for installations above 4ft, the sensor should be installed in upside orientation with the UP arrow facing down to avoid any blind spots near the ground.

Comparison table:

No.	Installation Height	Sensitivity	Sensor UP direction
1	1-1.4FT	LOW	UP
2	1.4-1.7FT	MIDDLE	UP
3	1.7-2FT	HIGH	UP
4	2-2.4FT	LOW	UP
5	2.4-2.7FT	MIDDLE	UP
6	2.7-3FT	HIGH	UP
7	3-3.4FT	LOW	DOWN
8	3.4-3.7FT	MIDDLE	DOWN
9	3.7-4FT	HIGH	DOWN

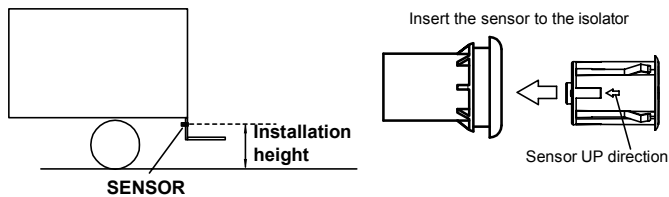

Parameters

No.	Item	Parameter
1	Rated voltage	DC12V
2	Working voltage	DC10V ~ DC16V
3	Working current	<400mA
4	Working Temp.	-40°C ~ +85°C
5	Storage Temp.	-40°C ~ +85°C
6	Detection distance	MAX 10FT
7	Image formats	NTSC
8	Sensors' waterproof level	IP67

Wiring diagram

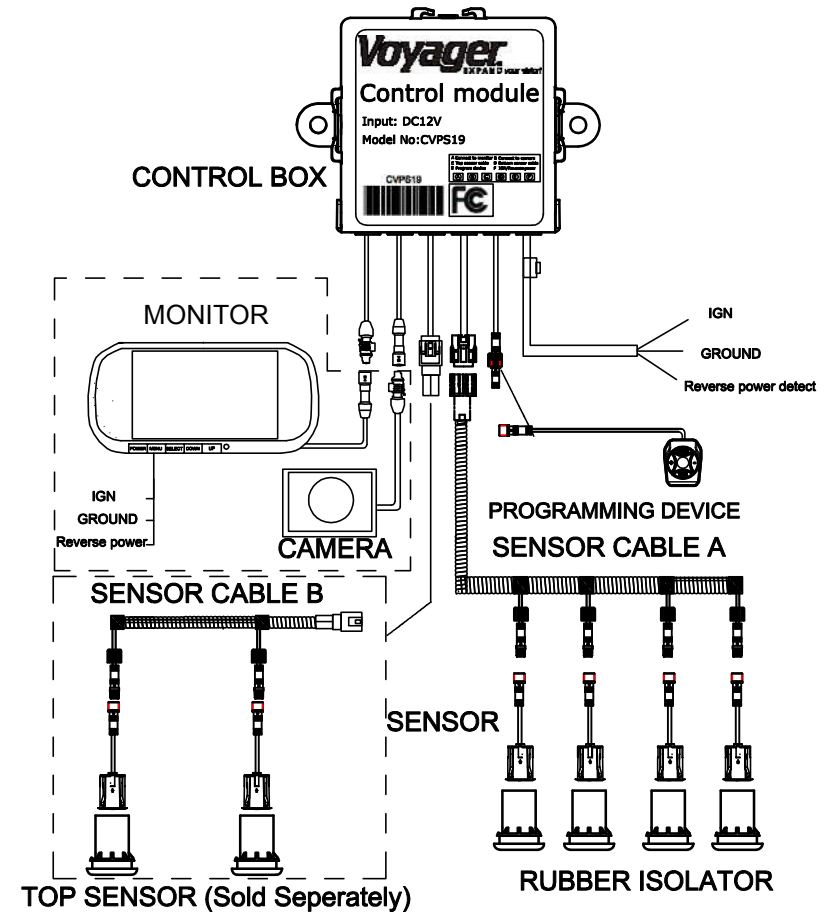

Required tools

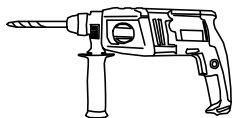

Electric Drill



Marker Pen



Tape Measure

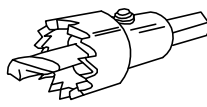

SPC5 (1 1/4")

Function

1 Self diagnosis

When the system detects the reverse trigger signal, the system will self-diagnose for proper functionality of the sensors. If any sensor is found to be malfunctioning, the corresponding sensor will indicate red on the monitor as depicted in the below image.

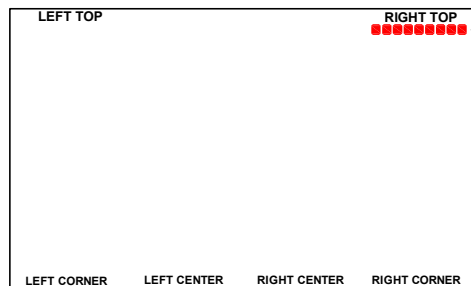

Self diagnosis is abnormal

2 Detection function

2.1 When obstacles are detected, the CVPS19 will give a visual and auditory alert. The chart below details the alert function on the 10 FT setting.

Distance	Warning frequency	OSD showing
8.0-10.0 FT	1 HZ	■
6.5-8.0 FT	1 HZ	■ ■
5.0-6.5 FT	1 HZ	■ ■ ■
4.0-5.0 FT	2 HZ	■ ■ ■ ■
3.0-4.0 FT	3 HZ	■ ■ ■ ■ ■
2.0-3.0 FT	4 HZ	■ ■ ■ ■ ■ ■
1.5-2.0 FT	5 HZ	■ ■ ■ ■ ■ ■ ■
1.0-1.5 FT	6 HZ	■ ■ ■ ■ ■ ■ ■ ■
0-1.0 FT	Constant Beep	■ ■ ■ ■ ■ ■ ■ ■ ■ ■

2.2 The monitor displays the sensor detection with colored blocks. The closest obstacle's distance will be displayed at the top of the monitor.

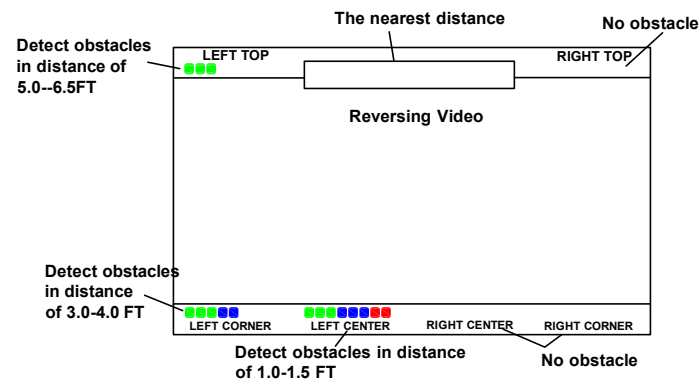

4 System setting

Connect and use the wired remote to make adjustments to the system settings.

Connect remote to main harness, press "MENU" to show the setup menu. Relatedly press "MENU" to cycle through the setup menu options.

Adjust the parameter key "-" & "+"

Press EXIT or leave inactive for 10 seconds to exit the setup menu. System will save all settings and remember the settings even if the power is removed.

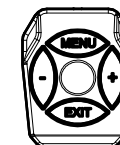

ENGLISH VERSION MENU:

Rear Step	<input type="radio"/> OFF	<input type="radio"/> 0.5FT	<input checked="" type="radio"/> 1FT	<input type="radio"/> 1.5FT
	<input type="radio"/> 2FT			
Sensitivity	<input type="radio"/> LOW	<input type="radio"/> MIDDLE	<input checked="" type="radio"/> HIGH	
Installation Height	<input type="radio"/> 1-2FT	<input checked="" type="radio"/> 2-3FT	<input type="radio"/> 3-4FT	
Top Corner Dis	<input type="radio"/> 5FT	<input type="radio"/> 8FT	<input type="radio"/> 10FT	<input checked="" type="radio"/> OFF
Bottom Center Dis	<input type="radio"/> 5FT	<input type="radio"/> 8FT	<input checked="" type="radio"/> 10FT	
Bottom Corner Dis	<input type="radio"/> 5FT	<input type="radio"/> 8FT	<input checked="" type="radio"/> 10FT	
Language	<input checked="" type="radio"/> ENGLISH	<input type="radio"/> SPANISH		
Factory Settings	<input checked="" type="radio"/> NO	<input type="radio"/> YES		

SPANISH VERSION MENU:

Paso Posterior	<input type="radio"/> OFF	<input type="radio"/> 0.5FT	<input checked="" type="radio"/> 1FT	<input type="radio"/> 1.5FT
	<input type="radio"/> 2FT			
Sensibilidad	<input type="radio"/> BAJA	<input type="radio"/> MEDIO	<input checked="" type="radio"/> ALTO	
Altura de montaje	<input type="radio"/> 1-2FT	<input checked="" type="radio"/> 2-3FT	<input type="radio"/> 3-4FT	
Dis de la esquina superior	<input type="radio"/> 5FT	<input type="radio"/> 8FT	<input type="radio"/> 10FT	<input checked="" type="radio"/> OFF
Dis de centro inferior	<input type="radio"/> 5FT	<input type="radio"/> 8FT	<input checked="" type="radio"/> 10FT	
Dis de la esquina inferior	<input type="radio"/> 5FT	<input type="radio"/> 8FT	<input checked="" type="radio"/> 10FT	
Idioma	<input type="radio"/> INGLES	<input checked="" type="radio"/> ESPAÑOL		
Ajustes De Fábrica	<input checked="" type="radio"/> NO	<input type="radio"/> SI		